

PROJECT op. II ・ 1 - 4

本 村 佳 久*

(2013年11月13日 受理)

建築設計：本村佳久

—HIROSHIMA GATEWAY TO WORLD PEACE—

Yoshihisa MOTOMURA*

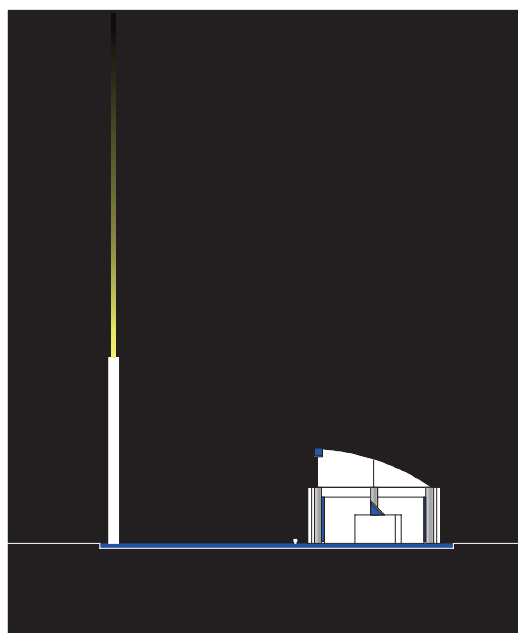

1

HIROSHIMA GATEWAY TO WORLD PEACE

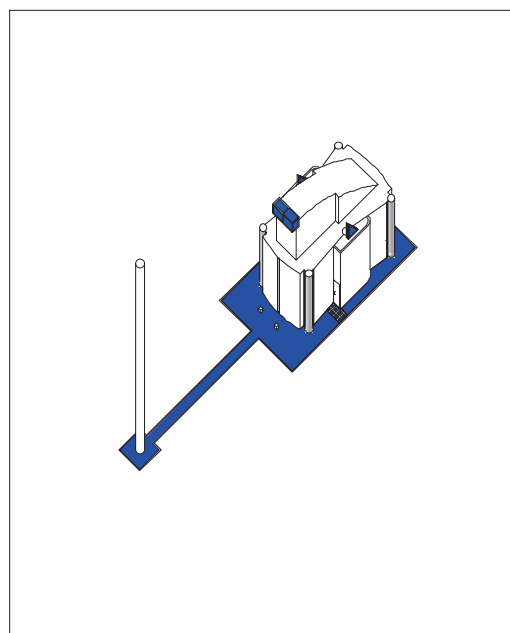

2

S.1:300 HIROSHIMA JOGAKUIN UNI. Prof.Y.MOTOMURA

* 広島女学院大学人間生活学部生活デザイン・建築学科教授

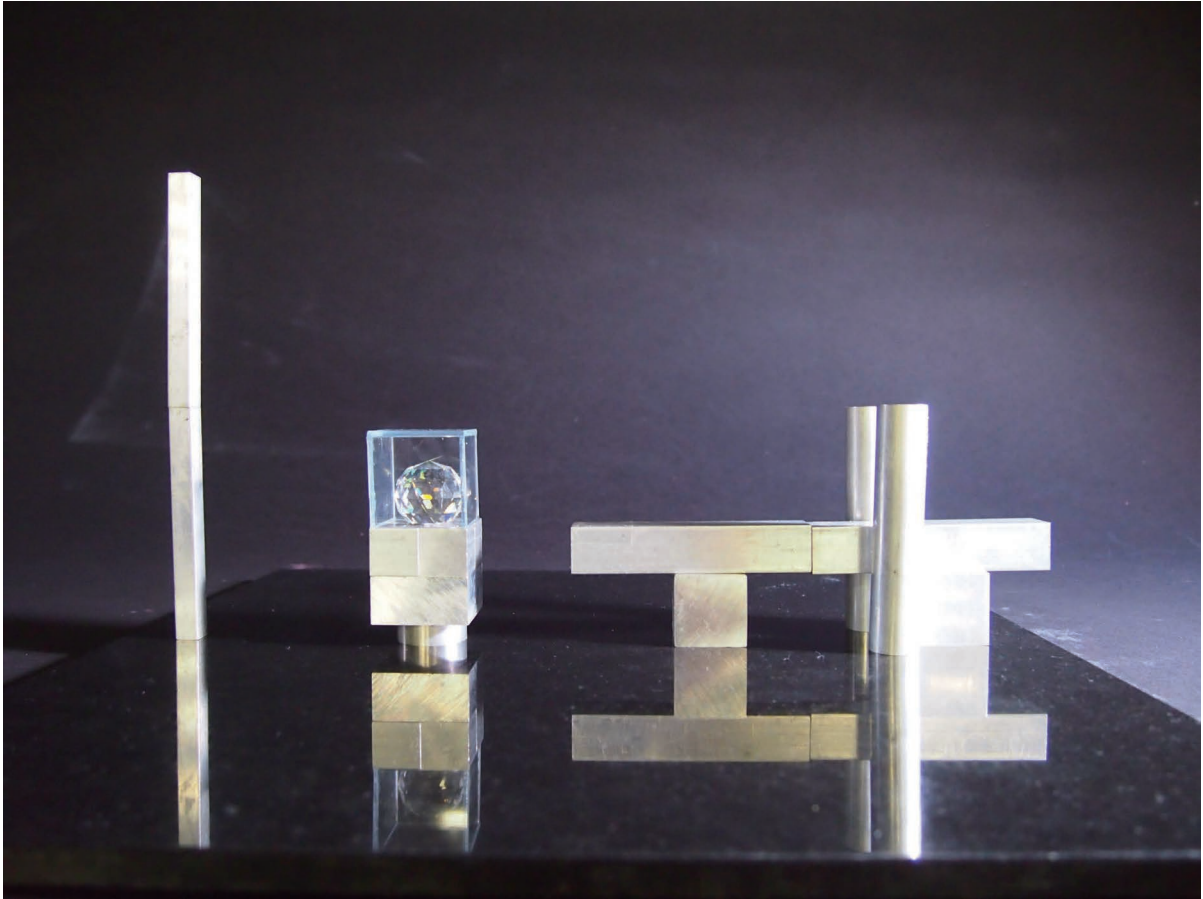

3

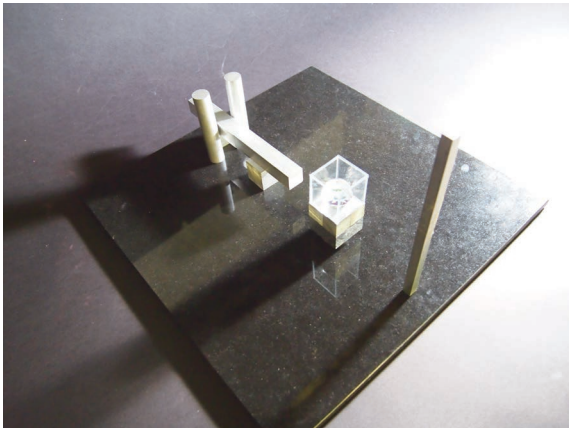

4

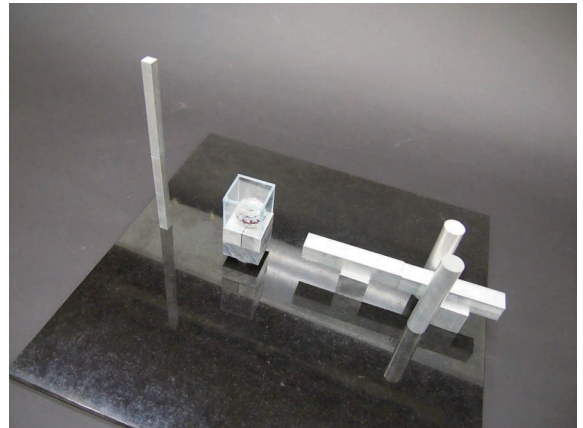

5

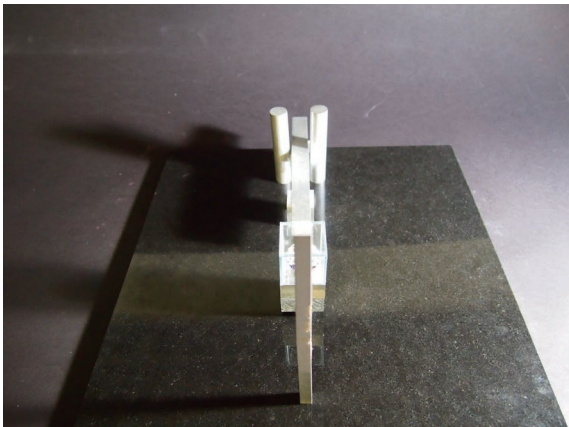

6

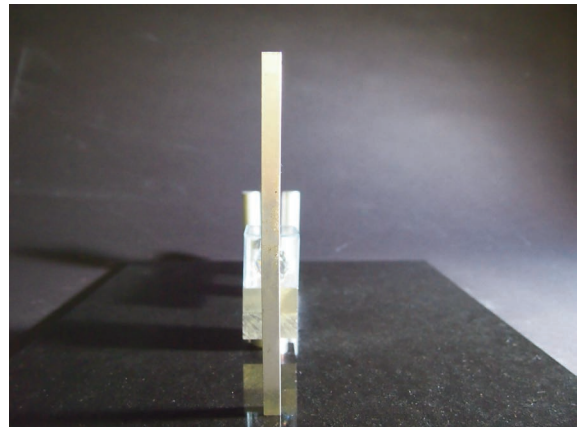

7

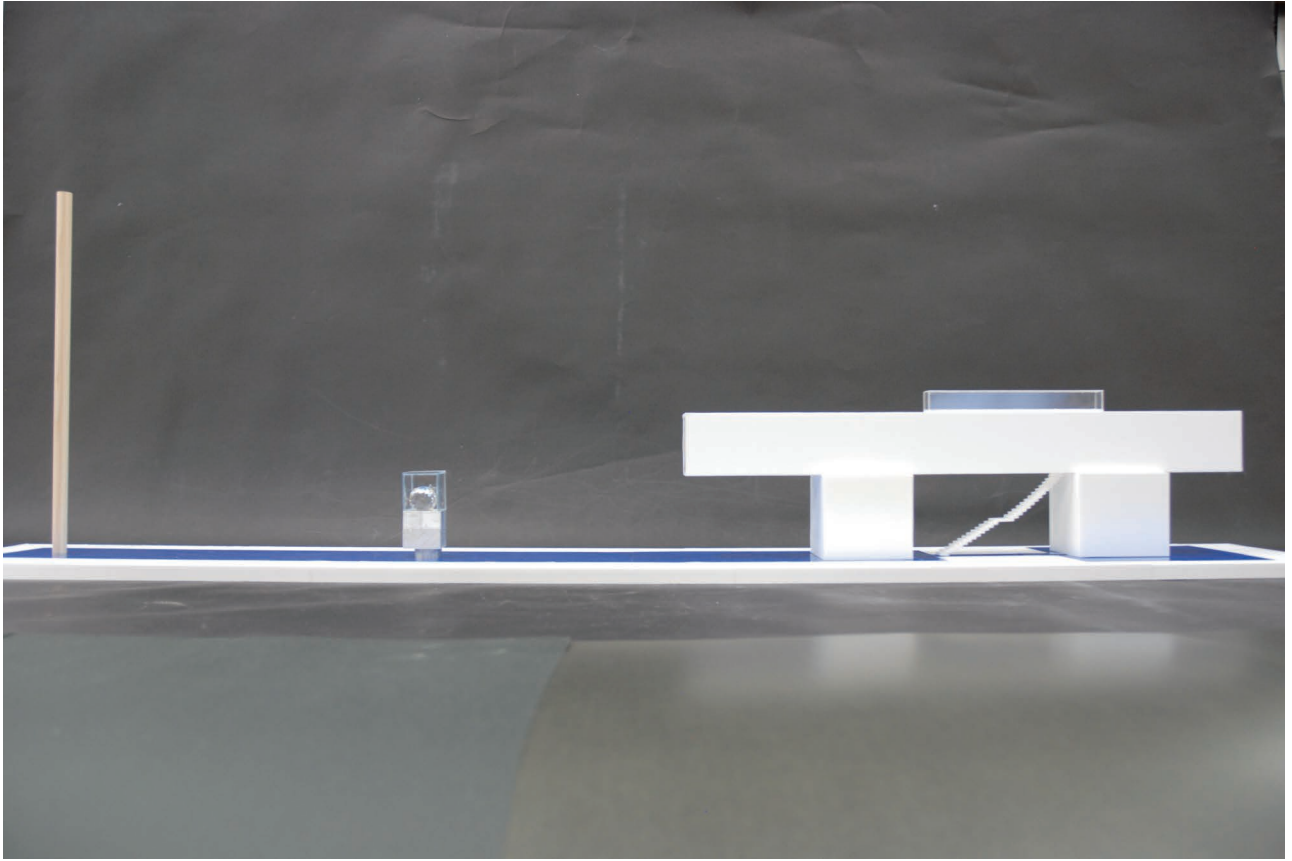

9

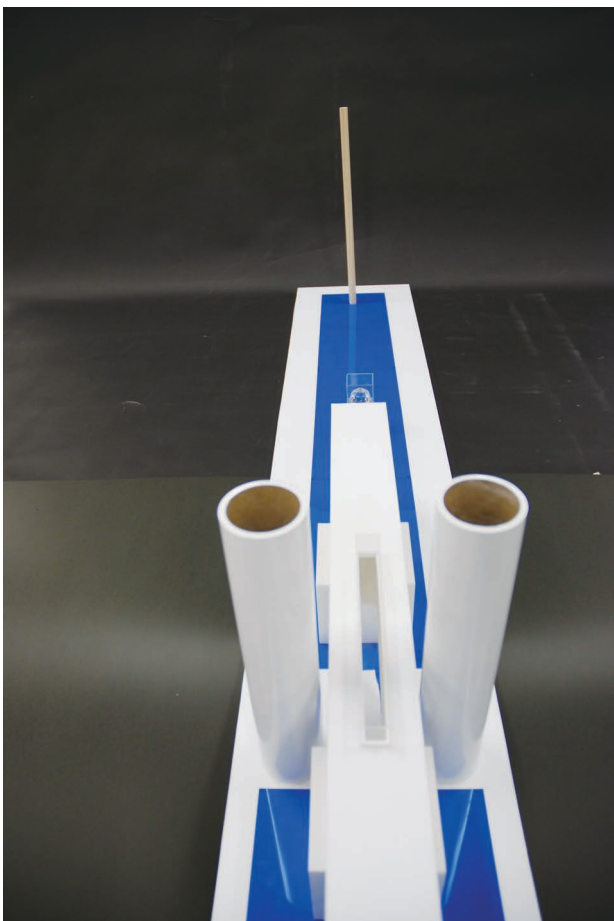

10

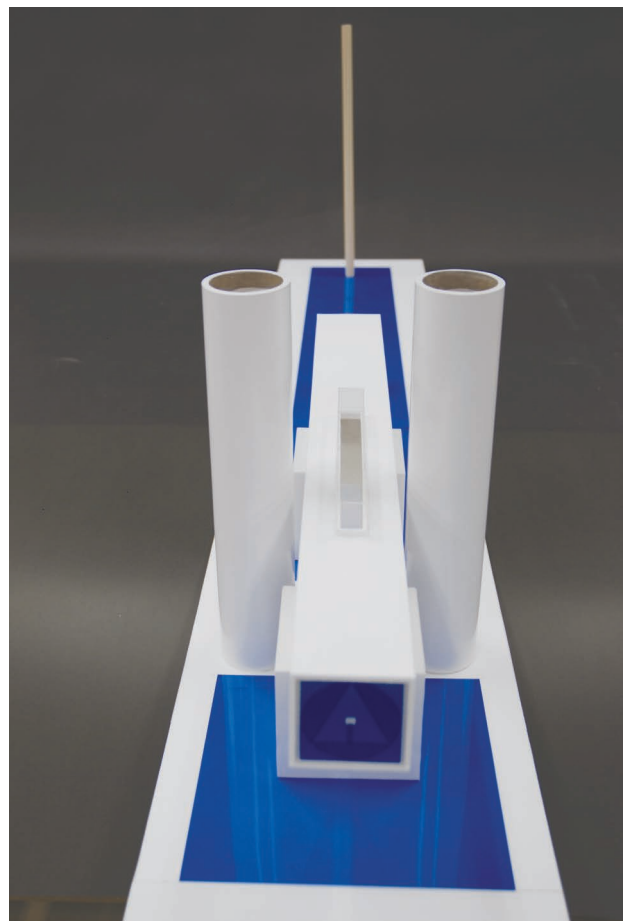

11

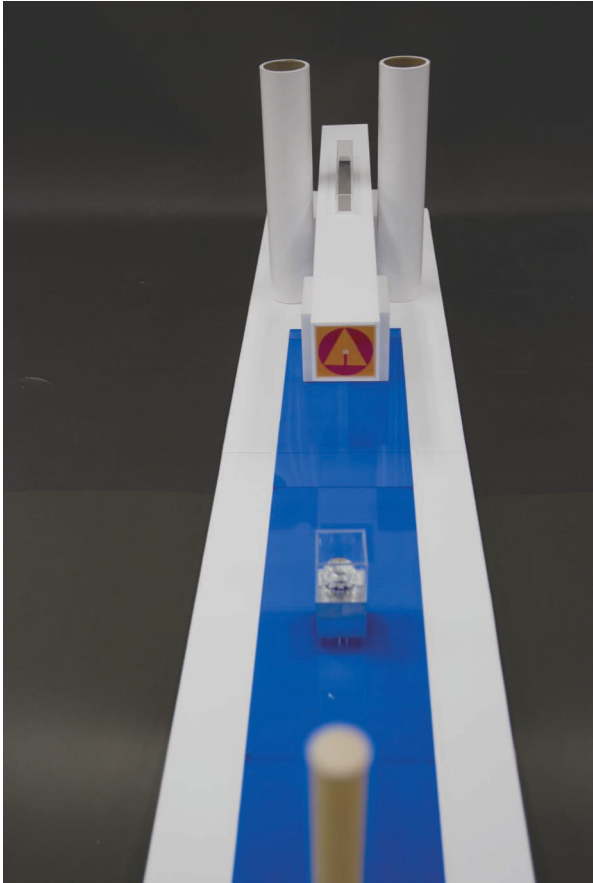

12

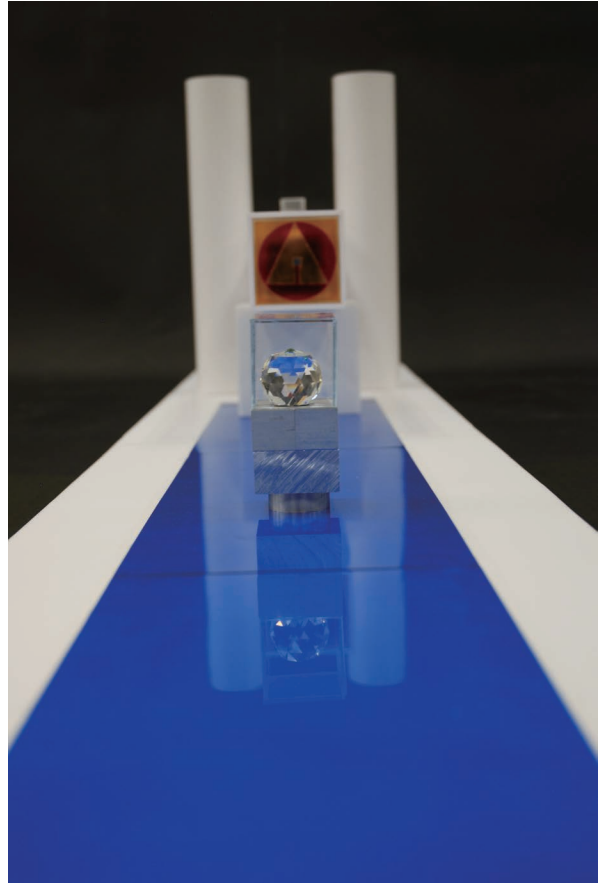

13

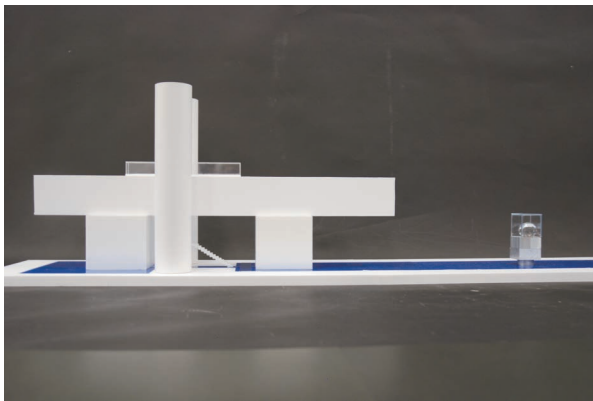

14

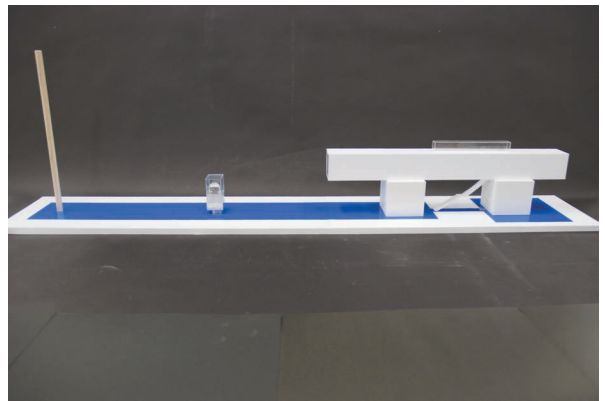

15

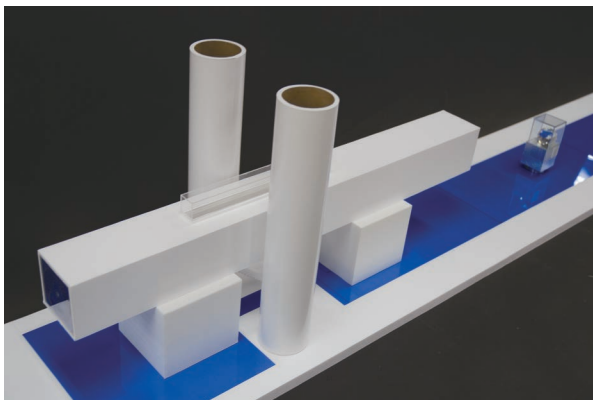

16

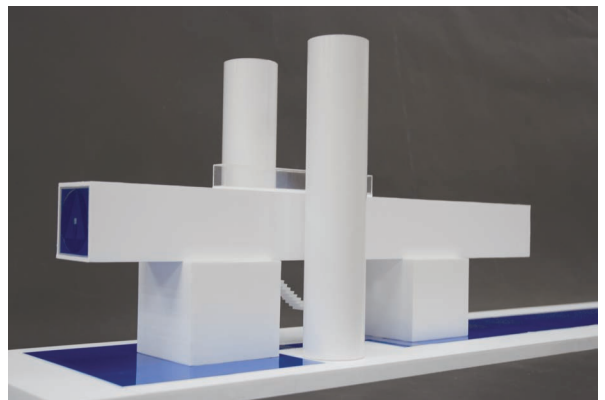

17

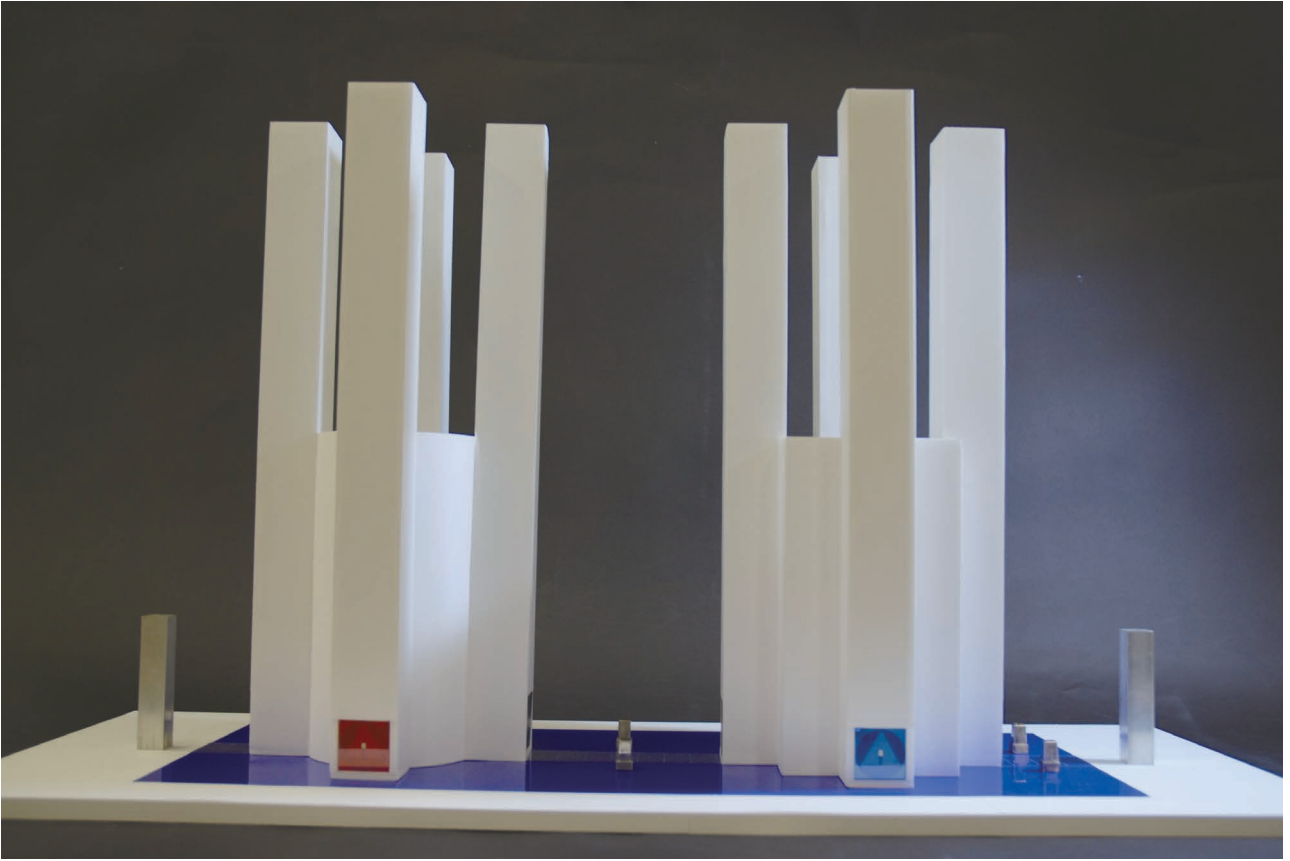

18

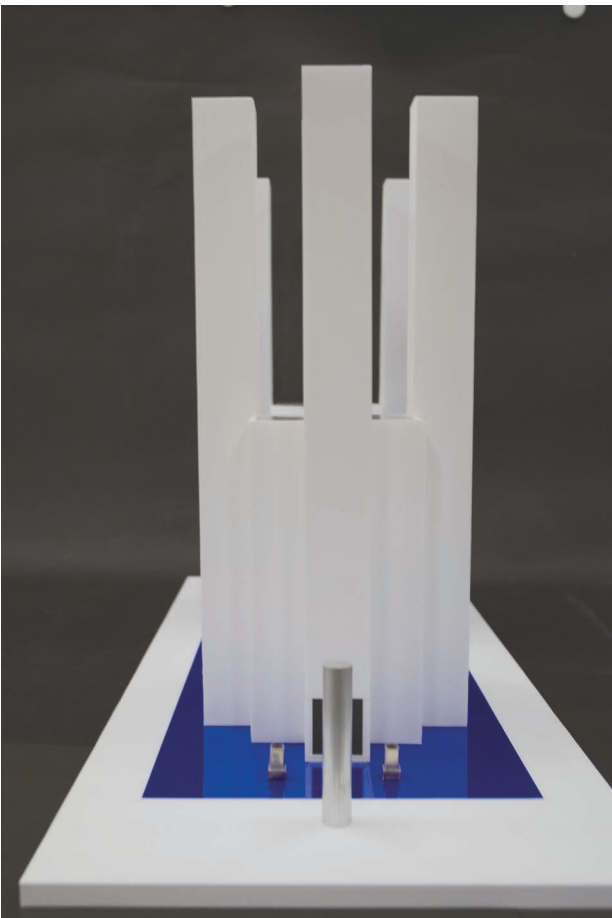

19

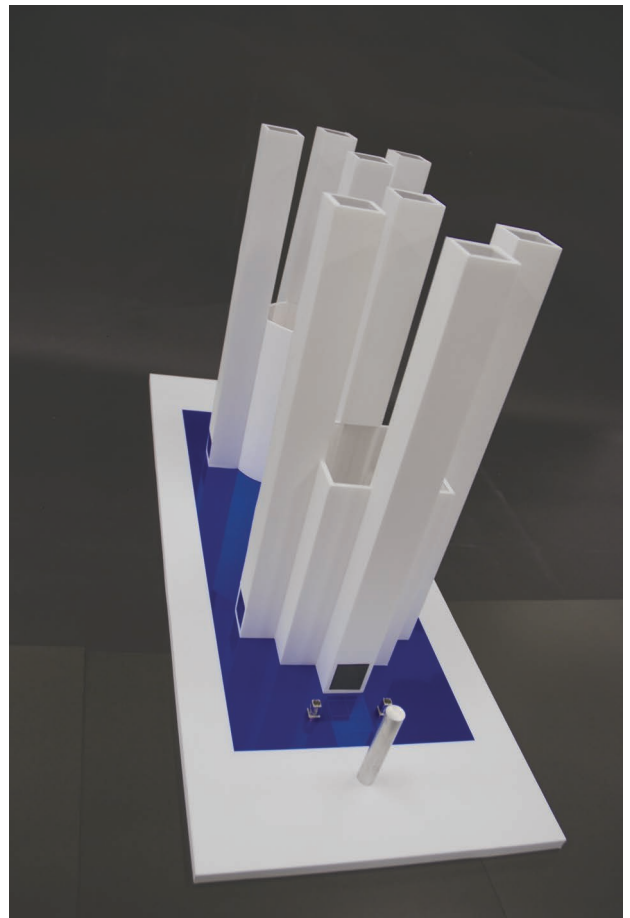

20

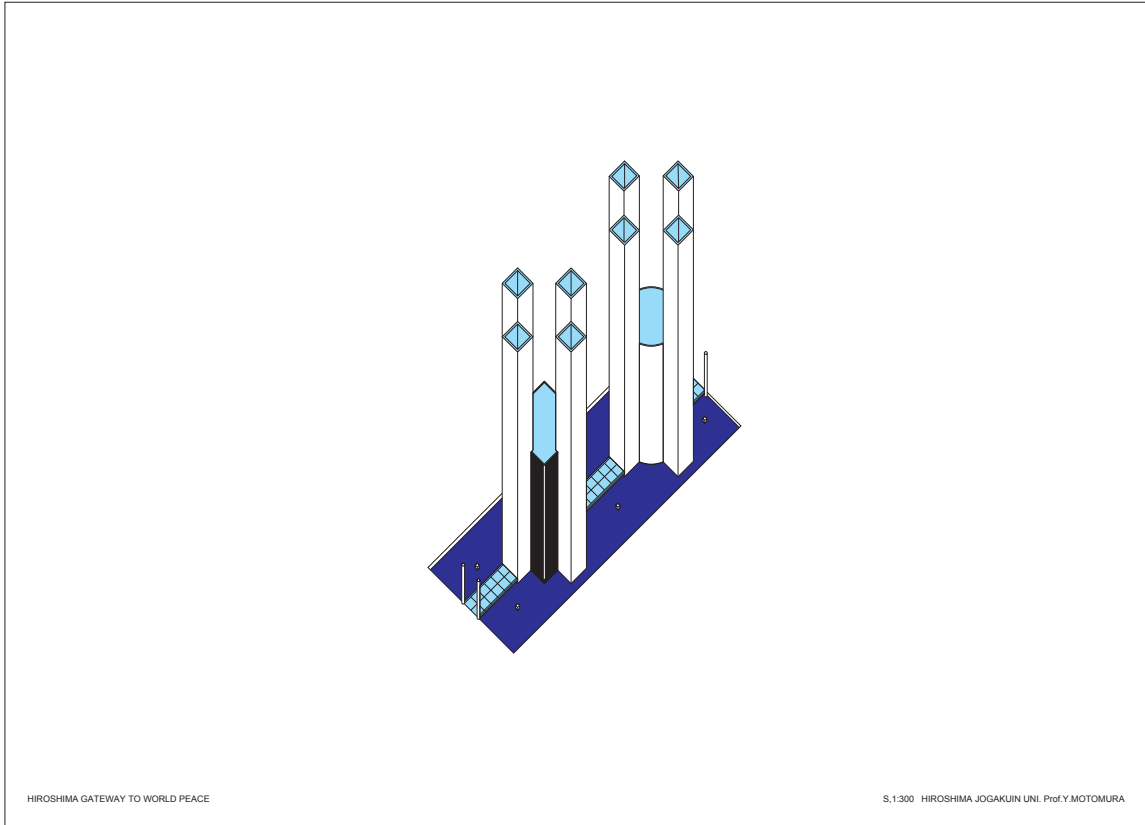

21

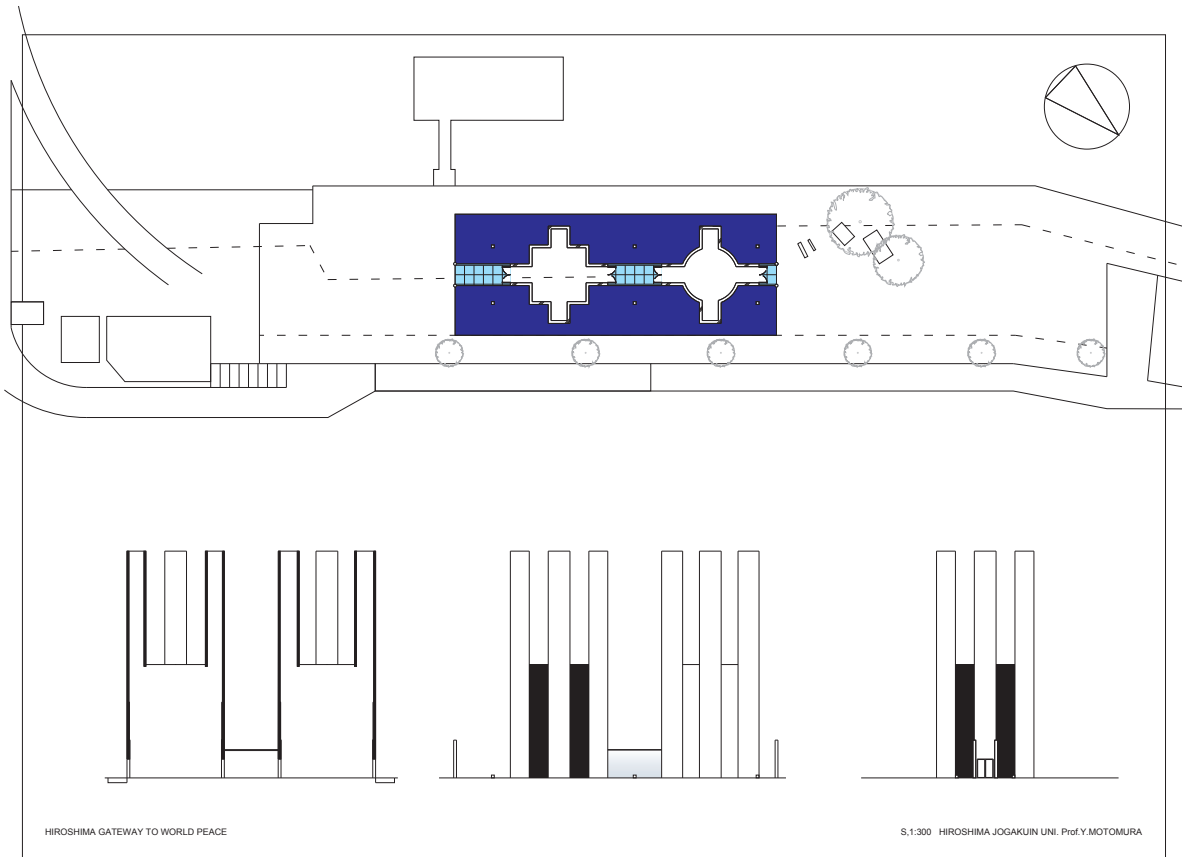

22

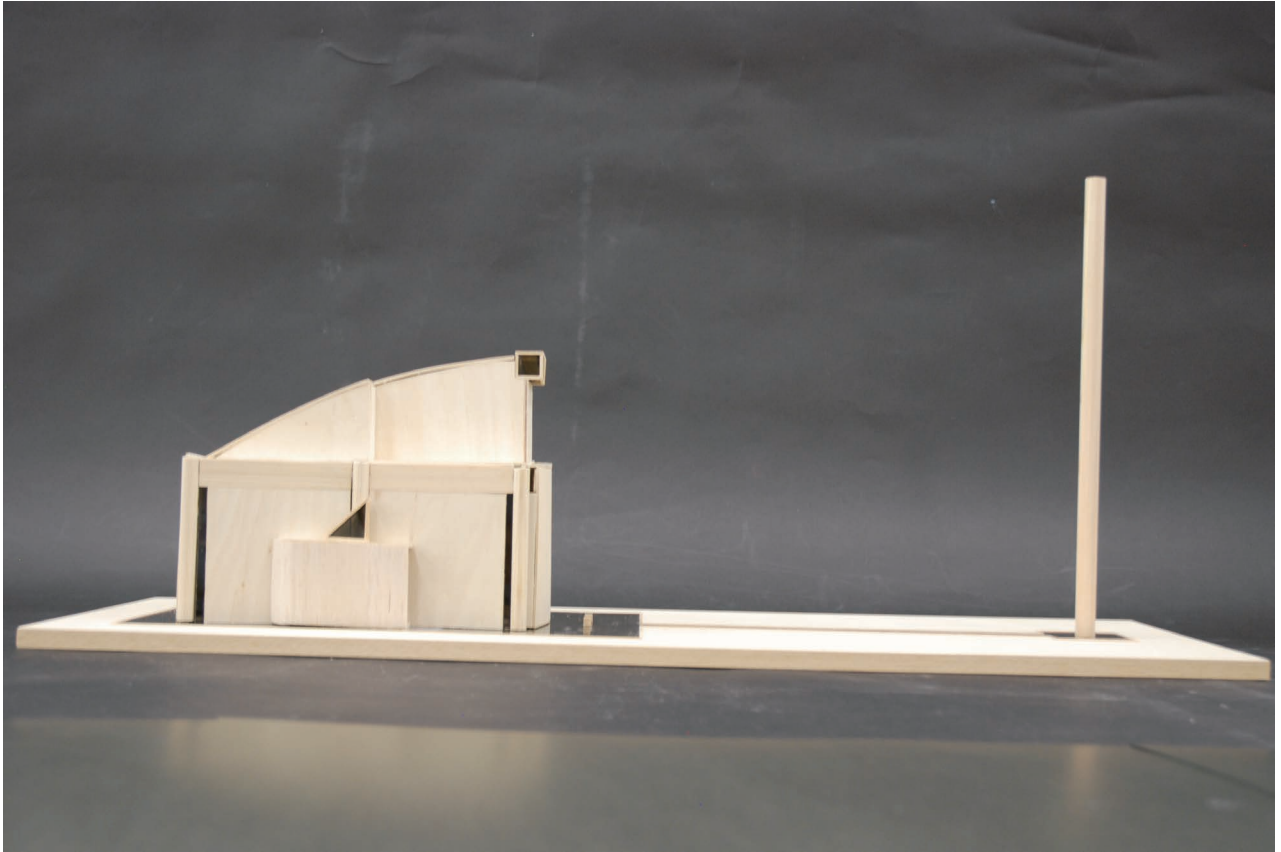

23

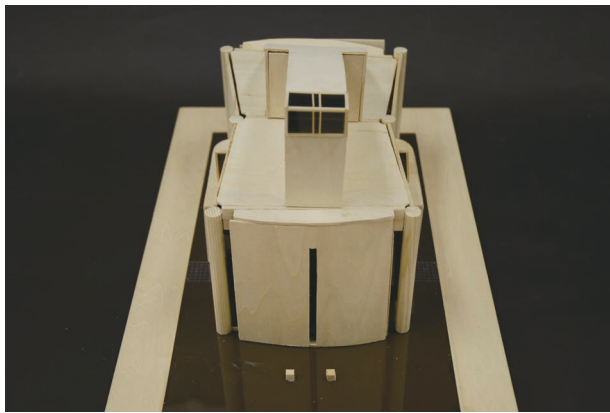

24

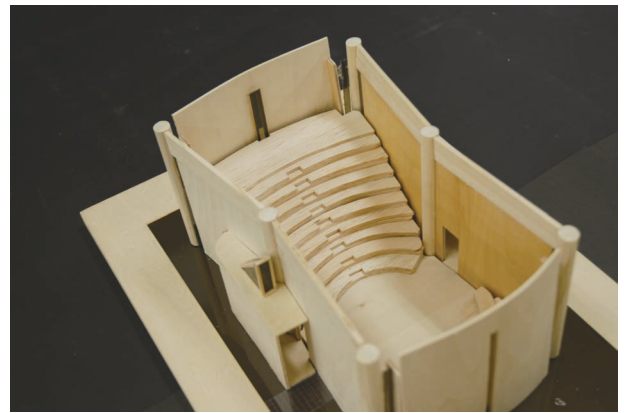

25



26

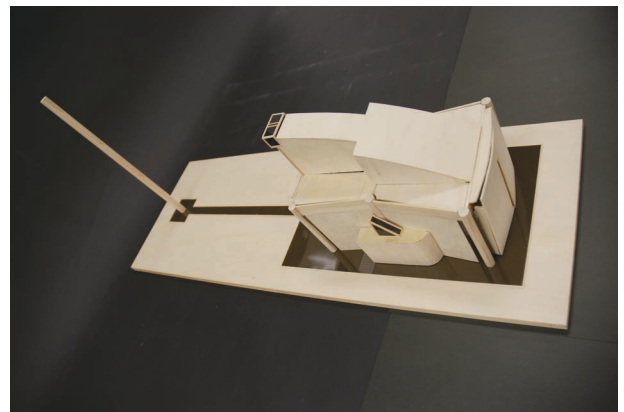

27

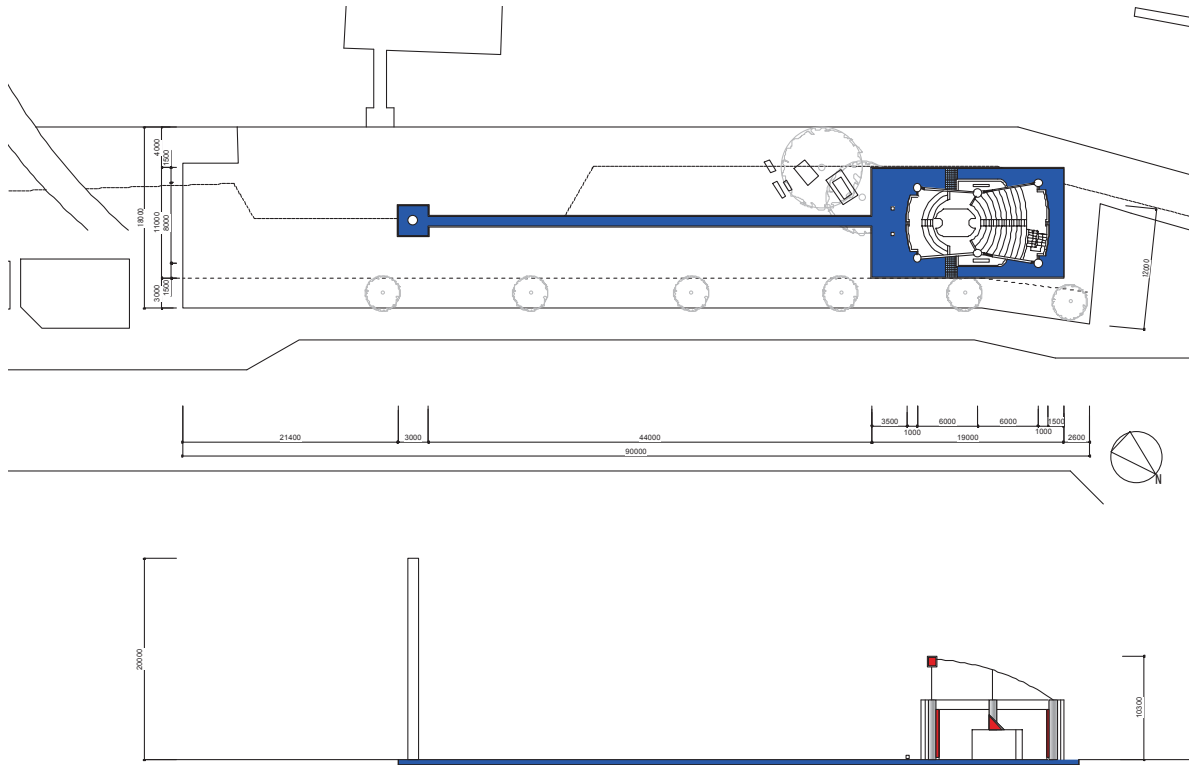

HIROSHIMA GATEWAY TO WORLD PEACE

S,1:300 HIROSHIMA JOGAKUIN UNI. Prof.Y.MOTOMURA

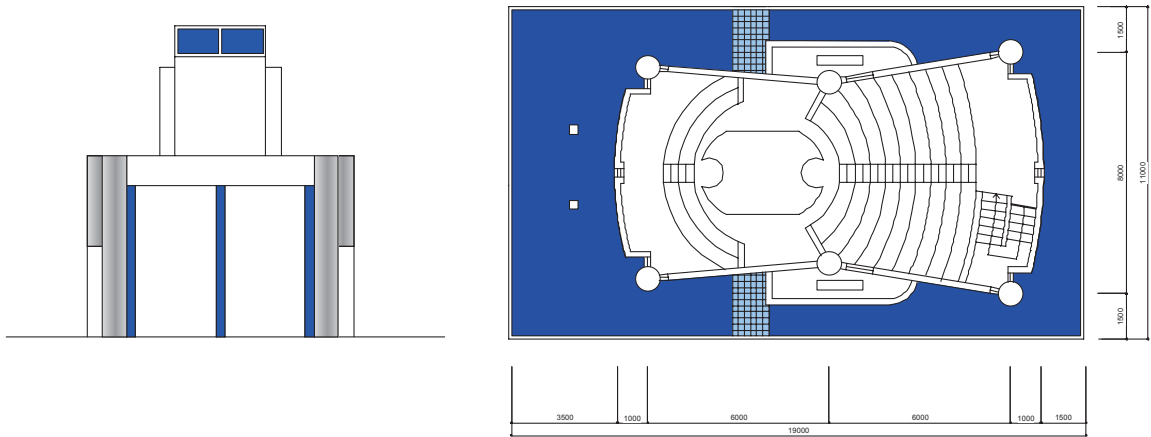

HIROSHIMA GATEWAY TO WORLD PEACE

S,1:100 HIROSHIMA JOGAKUIN UNI. Prof.Y.MOTOMURA



29

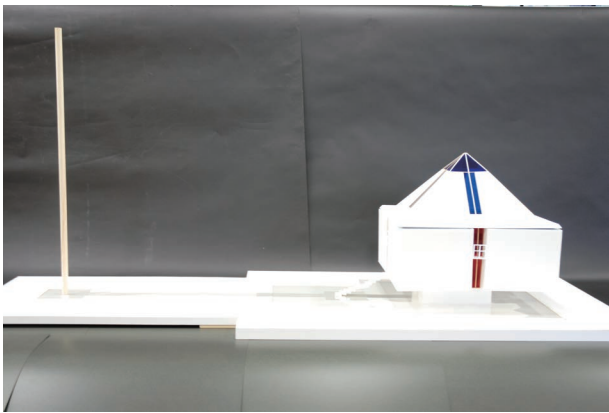

30

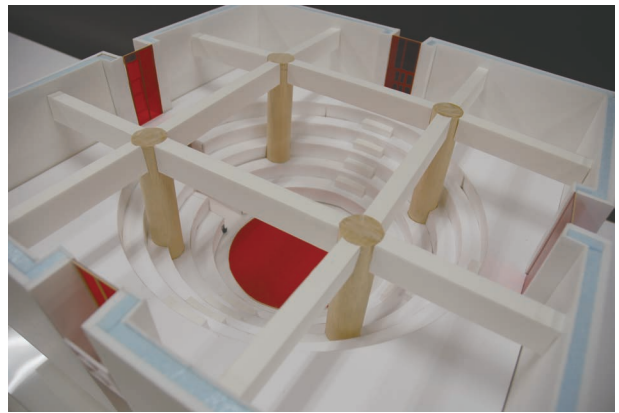

31



32



33

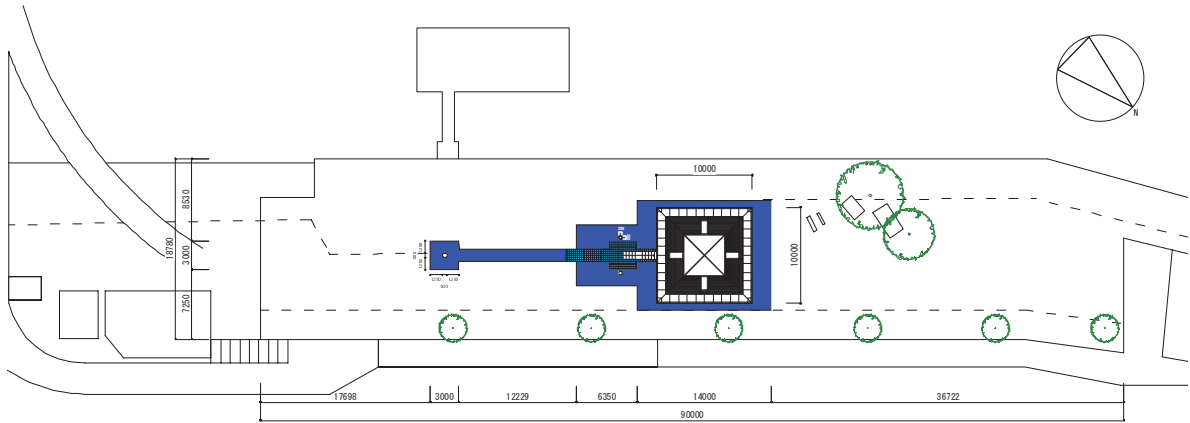

HIROSHIMA GATEWAY TO WORLD PEACE

S,1:300 HIROSHIMA JOGAKUIN UNI. Prof.Y.MOTOMURA

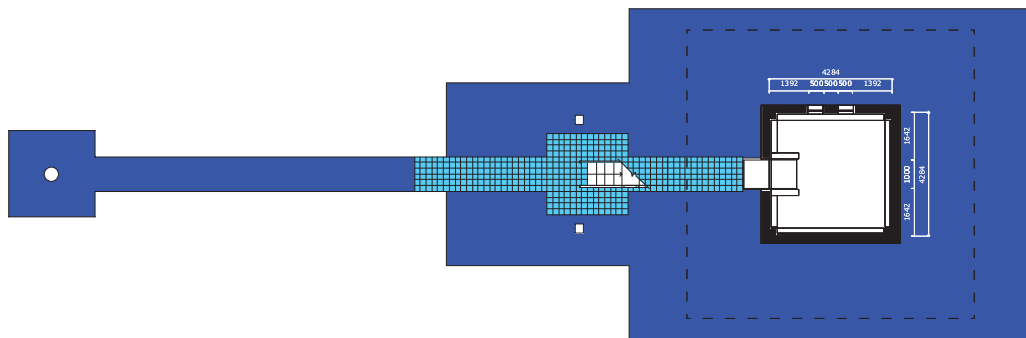
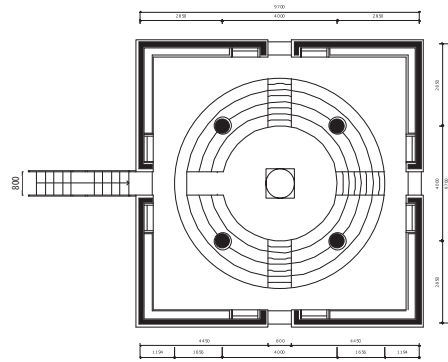
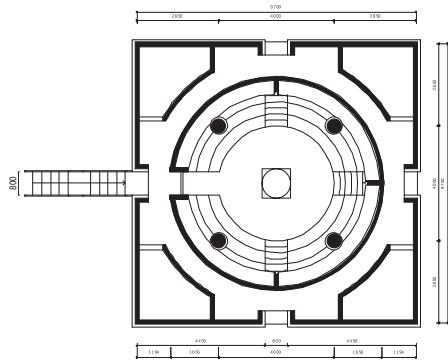

HIROSHIMA GATEWAY TO WORLD PEACE

S,1:100 HIROSHIMA JOGAKUIN UNI. Prof.Y.MOTOMURA

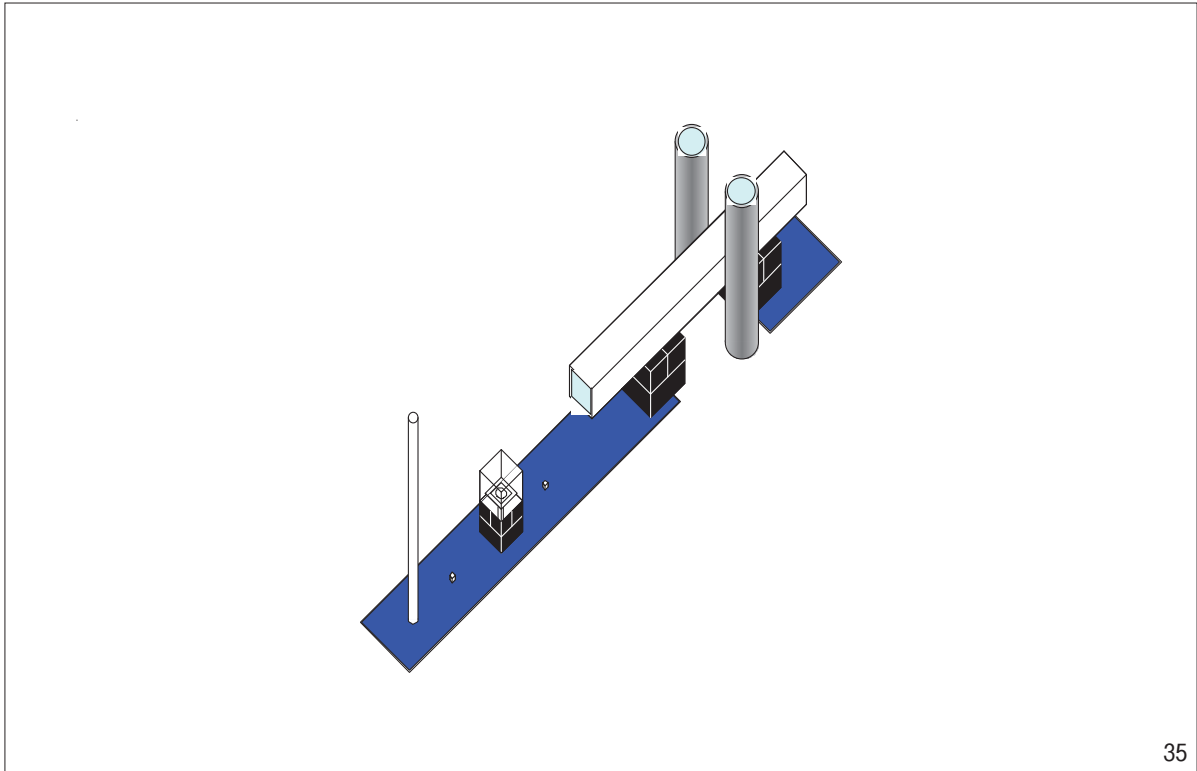

35

HIROSHIMA GATEWAY TO WORLD PEACE

S.1.300 HIROSHIMA JOGAKUIN UNI. Prof.Y.MOTOMURA

PROJECT op. II · 1 - 4

この建築は、ある方の願いにより広島市内に計画された。その思いは、子供の未来と世界の平和である。

ある彫刻家のヒロシマのための慰霊碑計画がある。これを納める建築を構想した。

子供たちの絵の展示・市民のための小さな音楽会等をも想定して、いくつかの案を考えた。塔は未来への希望。夜の光は鎮魂のろうそく。

この計画地の横に川が流れている。多くの方がそこで・・・

未来・平和と希望・祈り・・・

1 : PROJECT op. II · 3 (立面図), 2 : PROJECT op. II · 3 (透視図), 3 - 7 : PROJECT op. II · 1 (模型写真), 8 : PROJECT op. II · 1 (平・立・断面図), 9 - 17 : PROJECT op. II · 1 (模型写真), 18 - 20 : PROJECT op. II · 2 (模型写真), 21 : PROJECT op. II · 2 (透視図), 22 : PROJECT op. II · 2 (平・立・断面図), 23 - 27 : PROJECT op. II · 3 (模型写真), 28 : PROJECT op. II · 3 (平・立面図), 29 - 33 : PROJECT op. II · 4 (模型写真), 34 : PROJECT op. II · 4 (平・立面図), 35 : PROJECT op. II · 1 (透視図)